

LCO-LCC-LCP-LCL

Fissacavi ad inserimento laterale (brev.)

Versioni:

- ① **LCO** per piatto forato
- ② **LCC** per piatto, tondo e angolare
- ③ **LCP** per profilato **PCI 40/22**
- ④ **LCL** per passerelle portacavi in filo d'acciaio

Composizione:

- 1 - Sella doppia **SAL** di P.E.
- 2 - Barra filettata - **BFI** M8
- 3 - Piastre di spinta **PSL**
- 4 - Rondella elastica **REI 8**
- 5 - Dadi esagonali **DAI 8**

Impiego:

Fissaggio 1 - 6 cavi coassiali.
Fissaggio di guide d'onda mediante guarnizioni elastiche **GRE-GRQ**.

Materiale:

Acciaio INOX AISI 304 (V 2A).
H.D.P.E. resistente a U.V.
Colore: nero (grigio a richiesta).



LCO-LCC-LCP-LCL

Schellen mit seitlicher Einführung (Pat.)

Versionen:

- ① **LCO** für gelochtes Flacheisen
- ② **LCC** für Flach-, Rund-, Winkelisen
- ③ **LCP** für Profil **PCI 40/22**
- ④ **LCL** für Gitterbahnen

Zusammenbau:

- 1 - **SAL** Doppelwanne P.E.
- 2 - Gewindestange - **BFI** M8
- 3 - Druckplatten **PSL**
- 4 - **REI 8** Sicherungsscheiben
- 5 - **DAI 8** Muttern

Einsatz:

Befestigung von 1 - 6 Koaxialkabeln.
Mittels elastischen Klemmprofilen **GRE-GRQ** auch Wellenleiter.

Material:

Stahl AISI 304 (V2A).
H.D.P.E. U.V. - beständig.
Farbe: schwarz (grau auf Anfrage).

LCO-LCC-LCP-LCL

Fasteners for Side Insertion (pat.)

Versions:

- ① **LCO** for flat iron with holes
- ② **LCC** for flat, round, angular
- ③ **LCP** for **PCI 40/22** profile
- ④ **LCL** for steel wire cable trays

Components:

- 1 - **SAL** double Saddle in P.E.
- 2 - Threaded Bar - **BFI** M8
- 3 - **PSL** steel Flanges
- 4 - **REI 8** Elastic Washer
- 5 - **DAI 8** Hexagonal Nuts

Use:

Fixing 1 to 6 coaxial cables.
GRE-GRQ elastic cushions allow fastening of waveguides.

Material:

AISI 304 (V 2A) stainless Steel.
H.D.P.E., U.V. proof.
Colour: black (grey on request).

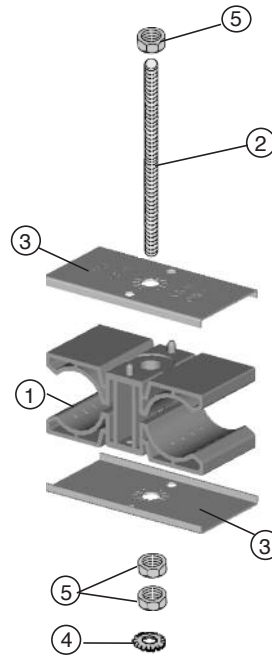

LCO-LCC-LCP-LCL

Fixations à insertion latérale (brev.)

Versions:

- ① **LCO** pour fer plat avec trous
- ② **LCC** pour plat, rond et cornière
- ③ **LCP** pour profilé **PCI 40/22**
- ④ **LCL** pour structures en fil acier

Composition:

- 1 - Double garniture **SAL** en P.E.
- 2 - Tiges filetées - **BFI** M8
- 3 - Plaques **PSL**
- 4 - Rondelles dentelées **REI 8**
- 5 - Ecrous hexagonaux **DAI 8**

Emploi:

Fixation de 1 à 6 câbles coaxiaux.
Fixation de guides d'onde avec garnitures **GRE-GRQ**.

Matériel:

Inox AISI 304 (V2A).
H.D.P.E. résistant aux U.V.
Couleur: noir (gris sur demande).

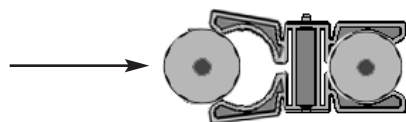

Inserimento laterale del cavo
Fasteners for Side Insertion
Schellen mit seitlicher Einführung
Fixations à insertion latérale

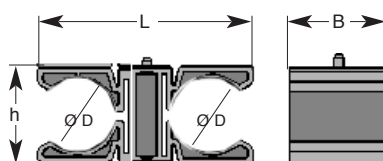

SAL - Sella elastica monoblocco gemellata
Montaggio rapido
Inserimento laterale del cavo

Materiale:

H.D.P.E. - U.V. resistente (-50°C ÷ +80°C)
Colore: nero, (grigio a richiesta)



SAL - Zweispurige Elastische Monoblock
Wanneen
Schnellmontage Seitliche
Kabel-Einführung

Material:

H.D.P.E. - U.V. beständig
Farbe: Schwarz, (grau auf Anfrage)

SAL - Elastic monobloc twin saddle
Speedy mounting
Side insertion of cables

Material:

H.D.P.E. - U.V. proof (-50°C ÷ +80°C)
Colour: black, (grey on request)

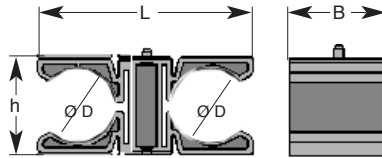

SAL - Garniture élastique monobloc jumellées
Montage rapide
Insertion latérale du câble

Matériel:

H.D.P.E. - Résistant aux rayons U.V. (-50°C ÷ +80°C)
Couleur: noir, (gris sur demande)

Figura Figure Abbildung Figure	Codice Code Artikel Nr. Code	Articolo Article Artikel Article	ø D	h	L	B			g	Prezzo Price Preis Prix	
	61 3308 0012	SAL/ 2x1/2"	16 - 17	27	62	39			20	500	30
	61 3308 0078	SAL/ 2x7/8"	27 - 29	38	84	39			20	100	40
	61 3308 0114	SAL/ 2x1.1/4"	38 - 40	50	102	39			20	100	75
	61 3308 0158	SAL/ 2x1.5/8"	50 - 52	61	119	39			20	100	100

BCO - Bussola compensatrice

Si usa quando una sede della sella
SAL resta libera

Materiale: H.D.P.E. - U.V. resistente
Colore: nero, (grigio a richiesta)

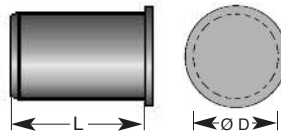

BCO - Compensating Bush

To be inserted when a seat of the
SAL saddle is not used

Material: H.D.P.E. - U.V. proof
Colour: black, (grey on request)

BCO - Ergänzungs Buchse

Verwendbar wenn ein Sitz der
SAL-Wanne frei bleibt

Material: H.D.P.E. - U.V. beständig
Farbe: schwarz, (grau auf Anfrage)

BCO - Manchon de compensation

A utiliser lorsque un siège de la garniture
SAL n'est pas utilisé

Matériel: H.D.P.E. - Résistant aux rayons U.V.
Couleur: noir, (gris sur demande)

Figura Figure Abbildung Figure	Codice Code Artikel Nr. Code	Articolo Article Artikel Article	ø D	L			g	Prezzo Price Preis Prix	
	61 3309 0012	BCO 1/2"	17	45			10	100	15
	61 3309 0078	BCO 7/8"	28	45			10	100	20
	61 3309 0114	BCO 1.1/4"	40	45			10	100	35
	61 3309 0158	BCO 1.5/8"	52	45			10	100	45

Esempi di combinazione
Combination examples

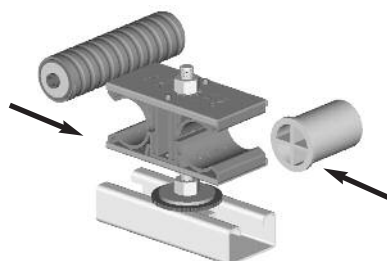

Kombination beispiele
Exemples de combinaison

LCO - Fissacavi rapidi per piatto forato

Inserimento laterale del cavo
Prefissaggio rapido elastico
Bloccaggio finale manuale

Composizione:
Sella **SAL** + perno filettato M8 + dadi + rondelle

LCO - Schnellmontagen an gelochtes Flacheisen

Seitliche Kabeleinführung
Elastische Vorbefestigung
Handliche Endbefestigung

Zusammenbau:
SAL Wannen + Gewindest. M8 + Muttern + Scheiben

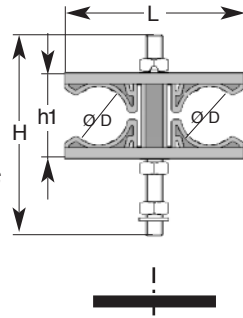

LCO - Quick-fit Fasteners for flat with holes

Side insertion of cables
Elastic prefixing
Manual final locking

Composition:
SAL Saddle + M8 threaded bar + nuts + washers

LCO - Fixations rapides sur plat avec trous

Insertion latérale des câbles
Préfixation élastique
Blocage final manuel

Composition:
Garniture **SAL** + tige fil. M8 + écrous + rondelles

Figura Figure Abbildung Figure	Codice Code Artikel Nr. Code	Articolo Article Artikel Article	Ø D	H	h1	L					g	Prezzo Price Preis Prix
<p>2 Cavi 2 Kabel</p>	61 1562 2012	LCO/ 2x1/2"	15-17	75	30	62	20				150	
	61 1562 2078	LCO/ 2x7/8"	27-29	75	41	84	20				165	
	61 1562 2114	LCO/ 2x1.1/4"	38-40	100	53	102	20				195	
	61 1562 2158	LCO/ 2x1.5/8"	50-52	100	64	119	20				215	
<p>4 Cavi 4 Kabel</p>	61 1562 4012	LCO/ 4x1/2"	15-17	100	54	62	20				185	
	61 1562 4078	LCO/ 4x7/8"	27-29	125	79	84	20				204	
	61 1562 4114	LCO/ 4x1.1/4"	38-40	150	103	102	20				265	
	61 1562 4158	LCO/ 4x1.5/8"	50-52	200	125	119	20				305	
<p>6 Cavi 6 Kabel</p>	61 1562 6012	LCO/ 6x1/2"	15-17	125	84	62	20				215	
	61 1562 6078	LCO/ 6x7/8"	27-29	150	117	84	20				245	
	61 1562 6114	LCO/ 6x1.1/4"	38-40	200	153	102	20				335	
	61 1562 6158	LCO/ 6x1.5/8"	50-52	250	186	119	20				385	

Esempio di fissaggio piatti forati
Fixings example on flat iron with holes

Befestigung-Beispiel an Flacheisen
Exemple de fixations sur fer plat avec trous

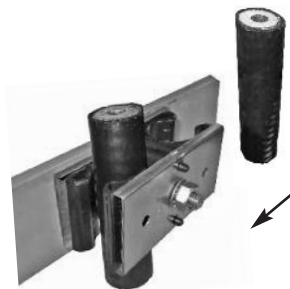

LCC - Fissacavi rapidi per piatti, tondi e angolari
Inserimento laterale del cavo
Prefissaggio rapido elastico
Bloccaggio finale manuale
 Composizione:
LCO + Morsetto monoblocco MCM 8

LCC - Schnellmontagen an Flach, Rund, Winkeleisen
Seitliche Kabeleinführung
Elastische Vorbefestigung
Handliche Endbefestigung
 Zusammenbau:
LCO + MCM 8 Kompakt-Klemme

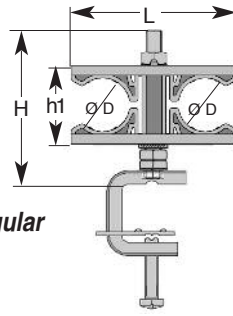

LCC - Quick-fit Fasteners for flat, round and angular
Side insertion of cables
Elastic prefixing
Manual final locking
 Composition:
LCO + MCM 8 compact Clamp

LCC - Fixations rapides sur plat, rond et cornière
Insertion latérale des câbles
Préfixation élastique
Blocage final manuel
 Composition:
LCO + Attache compacte MCM 8



Figura Figure Abbildung Figure	Codice Code Artikel Nr. Code	Articolo Article Artikel Article	ø D	H	h1	L			g 	Prezzo Price Preis Prix
2 Cavi 2 Kabel 2 Cables 2 Câbles	61 1563 2012	LCC/ 2x1/2"	15-17	75	30	62			240	
	61 1563 2078	LCC/ 2x7/8"	27-29	75	41	84			250	
	61 1563 2114	LCC/ 2x1.1/4"	38-40	100	53	102			280	
	61 1563 2158	LCC/ 2x1.5/8"	50-52	100	64	119			310	
4 Cavi 4 Kabel 4 Cables 4 Câbles	61 1563 4012	LCC/ 4x1/2"	15-17	100	54	62			270	
	61 1563 4078	LCC/ 4x7/8"	27-29	125	79	84			290	
	61 1563 4114	LCC/ 4x1.1/4"	38-40	150	103	102			350	
	61 1563 4158	LCC/ 4x1.5/8"	50-52	200	125	119			390	
6 Cavi 6 Kabel 6 Cables 6 Câbles	61 1563 6012	LCC/ 6x1/2"	15-17	125	84	62			300	
	61 1563 6078	LCC/ 6x7/8"	27-29	150	117	84			330	
	61 1563 6114	LCC/ 6x1.1/4"	38-40	200	153	102			420	
	61 1563 6158	LCC/ 6x1.5/8"	50-52	250	186	119			470	

Esempio di fissaggio su angolare
Fixings example on angular

Befestigung-Beispiel an Winkel Eisen
Exemple de fixations sur cornière

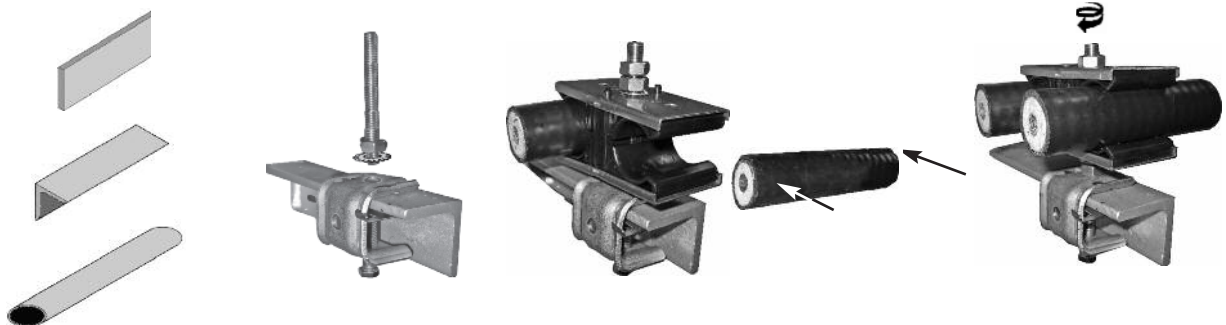

LCP - Fissacavi rapidi per profilato PCI 40x22

Inserimento laterale del cavo
Prefissaggio rapido elastico
Bloccaggio finale manuale

Composizione:
LCO + inserto scorrevole ISL 8

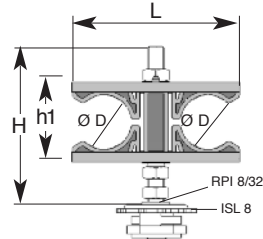

LCP - Schnellmontage für C-Profil 40x22

Seitliche Kabeleinführung
Elastische Vorbefestigung
Handliche Endbefestigung

Zusammenbau:
LCO + ISL 8 Schnellmontagemutter

LCP - Quick-fit Fasteners for PCI 40x22 section

Side insertion of cables
Elastic prefixing
Manual final locking

Composition:
LCO + ISL 8 sliding Insert



LCP - Fixations rapide pour profilé PCI 40x22

Insertion latérale des câbles
Préfixation élastique
Blocage final manuel

Composition:
LCO + adaptateur rapide ISL 8

Figura Figure Abbildung Figure	Codice Code Artikel Nr. Code	Articolo Article Artikel Article	ø D	H	h1	L			g 	Prezzo Price Preis Prix
<p>2 Cavi 2 Kabel</p> <p>h1 H</p> <p>2 Cables 2 Câbles</p>	61 1564 2012	LCP/ 2x1/2"	15-17	75	30	62			175	
	61 1564 2078	LCP/ 2x7/8"	27-29	100	41	84			185	
	61 1564 2114	LCP/ 2x1.1/4"	38-40	100	53	102			215	
	61 1564 2158	LCP/ 2x1.5/8"	50-52	125	64	119			245	
<p>4 Cavi 4 Kabel</p> <p>h1 H</p> <p>4 Cables 4 Câbles</p>	61 1564 4012	LCP/ 4x1/2"	15-17	100	54	62			205	
	61 1564 4078	LCP/ 4x7/8"	27-29	125	79	84			225	
	61 1564 4114	LCP/ 4x1.1/4"	38-40	200	103	102			285	
	61 1564 4158	LCP/ 4x1.5/8"	50-52	200	125	119			345	
<p>6 Cavi 6 Kabel</p> <p>h1 H</p> <p>6 Cables 6 Câbles</p>	61 1564 6012	LCP/ 6x1/2"	15-17	150	84	62			235	
	61 1564 6078	LCP/ 6x7/8"	27-29	200	117	84			265	
	61 1564 6114	LCP/ 6x1.1/4"	38-40	250	153	102			355	
	61 1564 6158	LCP/ 6x1.5/8"	50-52	250	186	119			445	

Esempio di fissaggio su profilati a "C"
Fixings example on "C"-profiles

Befestigung-Beispiel an "C"-Profil
Exemple de fixations sur profilé "C"



LCL - Fissacavi rapidi per passerelle in filo

Inserimento laterale del cavo
Prefissaggio rapido elastico
Bloccaggio finale manuale

Composizione:
LCO + 2 piastre di spinta PUC 70

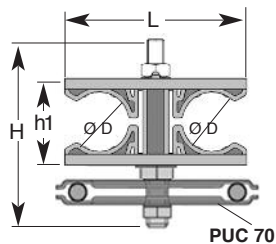

LCL - Schnellmontageschellen für Gitterbahnen

Seitliche Kabeleinführung
Elastische Vorbefestigung
Handliche Endbefestigung

Zusammenbau:
LCO + 2 PUC 70 Druckplatte

LCL - Quick-fit Fasteners

Side insertion of cables
Elastic prefixing
Manual final locking

Composition:
LCO + 2 PUC 70 steel pressure plates



LCL - Fixations rapides pour chemins de câbles en treillis

Insertion latérale des câbles
Préfixation élastique
Blocage final manuel

Composition:
LCO + 2 plaques de compression PUC 70

Figura Figure Abbildung Figure	Codice Code Artikel Nr. Code	Articolo Article Artikel Article	Ø D	H	h1	L			g 	Prezzo Price Preis Prix
2 Cavi 2 Kabel h1 H	61 1565 2012	LCL/ 2x1/2"	15-17	75	30	62			200	
	61 1565 2078	LCL/ 2x7/8"	27-29	75	41	84			215	
	61 1565 2114	LCL/ 2x1.1/4"	38-40	100	53	102			245	
	61 1565 2158	LCL/ 2x1.5/8"	50-52	100	64	119			280	
4 Cavi 4 Kabel h1 H	61 1565 4012	LCL/ 4x1/2"	15-17	100	54	62			235	
	61 1565 4078	LCL/ 4x7/8"	27-29	125	79	84			260	
	61 1565 4114	LCL/ 4x1.1/4"	38-40	150	103	102			330	
	61 1565 4158	LCL/ 4x1.5/8"	50-52	200	125	119			400	
6 Cavi 6 Kabel h1 H	61 1565 6012	LCL/ 6x1/2"	15-17	125	84	62			270	
	61 1565 6078	LCL/ 6x7/8"	27-29	150	117	84			305	
	61 1565 6114	LCL/ 6x1.1/4"	38-40	200	153	102			410	
	61 1565 6158	LCL/ 6x1.5/8"	50-52	250	186	119			510	

Esempio di fissaggio su passerelle fissacavi in filo d'acciaio
Fixings example on steel wire-mesh cable trays

Befestigung-Beispiel für Gitterbahnen
Example de fixations sur chemins de câble en treillis

