

**SAC - Bi-selle calibrate con cerniera flessibile per RF, RG e FO**

Le miniselle doppie SAC, destinate al fissaggio di cavi di piccolo diametro, sono costituite da due semiselle calibrate incernierate tra loro. Vengono chiuse a scatto su una coppia di cavi, restandovi bloccate.

I due cavi, così trattenuti, vengono trascinati al punto di fissaggio ed ivi bloccati definitivamente mediante viti e perni filettati M8/M10, o morsetti fissacavi sRF.

I cavi sono trattenuti delicatamente grazie alla particolare geometria interna delle miniselle SAC.

Sono particolarmente raccomandate per cavi RG e FO.

**Materiale:**

P.A. 6 - resistente ai raggi U.V. (-30°C ÷ +120°C)  
Colore: nero (grigio a richiesta).



**SAC - Calibrated Double Saddles with flexible hinge for RF, RG and FO**

SAC Mini double saddles are used for small diameter cables. They consist of two hinged calibrated half saddles that snap down on couples of cables, remaining blocked on the cables to be fixed.

The two cables, can be led to the fixing point and finally blocked there through M8/M10 threaded bars and screws, or sRF Cable Clamps.

Cables are gently held, thanks to the internal special geometry of the saddles. They are specially recommended for RG and FO cables.

**Material:**

P.A. 6 - U.V. proof (-30°C ÷ +120°C)  
Colour: black (grey on request).

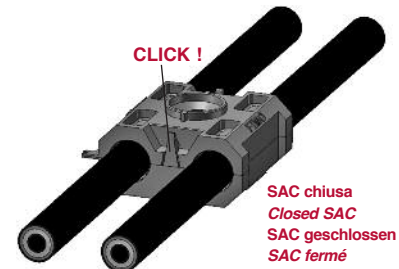
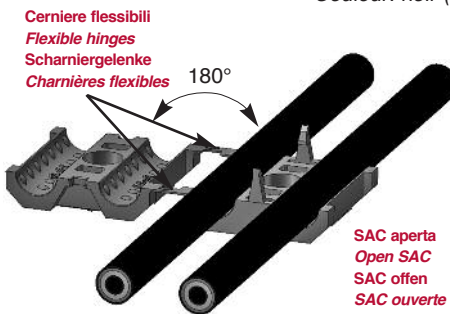
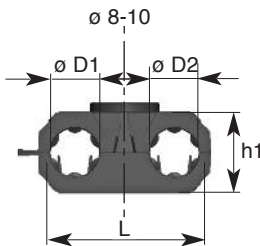

**SAC - Kalibrierte Doppelwannen mit Schnappverschluss für RF, RG und LWL**

Die SAC Mini-Doppelwannen sind besonders für kleine Kabeldurchmesser geeignet. Die zwei Halbschalen werden durch ein flexibles Scharniergelenk zusammengehalten. Sie werden jeweils auf zwei Kabel aufgesetzt und eingerastet.

Die zwei Kabel werden so gehalten, an die Befestigungsstelle geführt und mittels M8/M10 Gewindestangen bzw. Schrauben, oder sRF-Schellen befestigt.

Die Kabel werden schonend geführt dank der kalibrierten Sättel der SAC Doppelwannen. Sie sind besonders für RG-Kabel und LWL geeignet.

**Material:**

P.A. 6 - U.V. beständig (-30°C ÷ +120°C)  
Farbe: schwarz (grau auf Anfrage).

**SAC - Garnitures doubles calibrées avec charnière flexible pour RF, RG et FO**

SAC Mini-garnitures doubles, destinées à la fixation de câbles de petit diamètre, sont composées par deux demi-garnitures reliées par une charnière flexible. Elles sont fermées par déclenchement sur un couple de câbles. Les deux câbles, sont entraînés jusqu'au point de fixation et bloqués définitivement par tiges filetées et vis M8/M10, ou attaches sRF.

Les câbles sont maintenus délicatement grâce à la forme calibrée de la garniture.

La garniture SAC est particulièrement indiquée pour les câbles RG et FO.

**Matériel:**

P.A. 6 - résistant aux rayons U.V. (-30°C ÷ +120°C)  
Couleur: noir (gris sur demande).

Figura Figure Abbildung Figure	Codice Code Artikel Nr. Code	Articolo Article Artikel Article	ø D1	ø D2	h1	L			g	Prezzo Price Preis Prix
	61 3307 7207	SAC 2x7	5 - 7	5 - 7	18,5	34	20	500	12	
	61 3307 7209	SAC 2x9	7 - 9	7 - 9	18,5	34	20	500	12	
	61 3307 7211	SAC 2x11	9 - 11	9 - 11	18,5	34	20	500	12	
	61 3307 0709	SAC 1x7/9	5 - 7	7 - 9	18,5	34	20	500	12	
	61 3307 0711	SAC 1x7/11	5 - 7	9 - 11	18,5	34	20	500	12	
	61 3307 0714	SAC 1x7/14	5 - 7	11 - 14	24	46	20	500	30	
	61 3307 2714	SAC 2x7/14	5 - 7	11 - 14	24	46	20	500	25	
	61 3307 2214	SAC 2x14	11 - 14	11 - 14	24	46	20	500	22	
	61 3307 2212	SAC 2x1/2"	14 - 17	14 - 17	24	46	20	500	18	

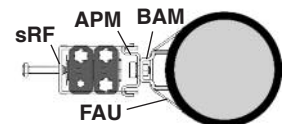
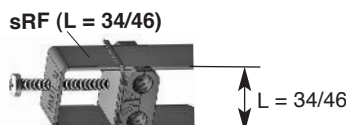
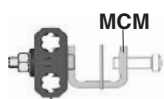

SOLUZIONI  
PER L'INSTALLAZIONE

SOLUTIONS  
FOR INSTALLATIONS



LÖSUNGEN  
FÜR INSTALLATIONEN

SOLUTIONS  
POUR L'INSTALLATION

**MCO - Mini fissacavi per piatto forato**

Composizione:  
Sella **SAC** + perno filettato M8 + dadi + rondelle



**MCO - Mini-Klemmen für gelochtes Flacheisen**

Zusammenbau:  
**SAC** Wanne + Gewindest. M8 + Muttern + Scheiben

**MCO - Mini-Clamps for flat iron with holes**

Composition:  
**SAC** Saddle + M8 threaded bar + nuts + washers

**MCO - Mini fixation pour fer plat avec trous**

Composition:  
Garniture **SAC** + tige fil. M8 + écrous + rondelles

Figura Figure Abbildung Figure	Codice Code Artikel Nr. Code	Articolo Article Artikel Article	ø D	H	h1			g 	Prezzo Price Preis Prix
 2 Cavi 2 Kabel h1 H 2 Cables 2 Câbles	61 1569 0207	<b>MCO 2 x 7</b>	5 - 7	50	18,5	20		45	
	61 1569 0209	<b>MCO 2 x 9</b>	7 - 9	50	18,5	20		45	
	61 1569 0211	<b>MCO 2 x 11</b>	9 - 11	50	18,5	20		45	
	61 1569 0214	<b>MCO 2 x 14</b>	11 - 14	50	24	20		55	
	61 1569 0212	<b>MCO 2 x 1/2"</b>	14 - 17	50	24	20		51	
 4 Cavi 4 Kabel h1 H 4 Cables 4 Câbles	61 1569 0407	<b>MCO 4 x 7</b>	5 - 7	75	37	20		65	
	61 1569 0409	<b>MCO 4 x 9</b>	7 - 9	75	37	20		65	
	61 1569 0411	<b>MCO 4 x 11</b>	9 - 11	75	37	20		65	
	61 1569 0414	<b>MCO 4 x 14</b>	11 - 14	100	48	20		93	
	61 1569 0412	<b>MCO 4 x 1/2"</b>	14 - 17	100	48	20		85	
 6 Cavi 6 Kabel h1 H 6 Cables 6 Câbles	61 1569 0607	<b>MCO 6 x 7</b>	5 - 7	100	55,5	20		85	
	61 1569 0609	<b>MCO 6 x 9</b>	7 - 9	100	55,5	20		85	
	61 1569 0611	<b>MCO 6 x 11</b>	9 - 11	100	55,5	20		85	
	61 1569 0614	<b>MCO 6 x 14</b>	11 - 14	125	72	20		123	
	61 1569 0612	<b>MCO 6 x 1/2"</b>	14 - 17	125	72	20		111	



A richiesta possibili combinazioni di due diversi diametri per sella **SAC** - vedere pag. 1 43  
 On request special combinations of two different diameters for each **SAC** Saddle - see page 1 43  
 Nach Anfrage Sonderkombination mit zwei unterschiedlichen Durchmessern pro **SAC** Schelle - siehe Seite 1 43  
 Sur demande des combinaisons spéciales de deux diamètres différents pour garniture **SAC** - voir page 1 43

Esempio di fissaggio piatti forati  
 Fixings example on flat iron with holes



Befestigung-Beispiel an gelochtes Flacheisen  
 Example de fixations sur fer plat avec trous

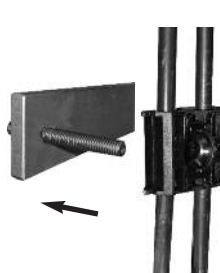

**MCC - Mini fissacavi per piatti, tondi e angolari**

Composizione:  
**MCO + mini morsetto MIM 8**



**MCC - Mini-Klemmen für Flach, Rund, Winkeleisen**

Zusammenbau:  
**MCO + Miniklemme MIM 8**

**MCC - Mini-Clamps for flat, round and angular**

Composition:  
**MCO + MIM 8 Mini Clamp**



**MCC - Mini fixation pour fer plat, rond et cornière**

Composition:  
**MCO + mini fixation MIM 8**

Figura Figure Abbildung Figure	Codice Code Artikel Nr. Code	Articolo Article Artikel Article	ø D	H	h1			g 	Prezzo Price Preis Prix
2 Cavi  2 Kabel 2 Cables 2 Câbles	61 1570 0207	<b>MCC 2 x 7</b>	5 - 7	50	18,5			120	
	61 1570 0209	<b>MCC 2 x 9</b>	7 - 9	50	18,5			120	
	61 1570 0211	<b>MCC 2 x 11</b>	9 - 11	50	18,5			120	
	61 1570 0214	<b>MCC 2 x 14</b>	11 - 14	50	24			130	
	61 1570 0212	<b>MCC 2 x 1/2"</b>	14 - 17	50	24			126	
4 Cavi  4 Kabel 4 Cables 4 Câbles	61 1570 0407	<b>MCC 4 x 7</b>	5 - 7	75	37			140	
	61 1570 0409	<b>MCC 4 x 9</b>	7 - 9	75	37			140	
	61 1570 0411	<b>MCC 4 x 11</b>	9 - 11	75	37			140	
	61 1570 0414	<b>MCC 4 x 14</b>	11 - 14	100	48			168	
	61 1570 0412	<b>MCC 4 x 1/2"</b>	14 - 17	100	48			160	
6 Cavi  6 Kabel 6 Cables 6 Câbles	61 1570 0607	<b>MCC 6 x 7</b>	5 - 7	100	55,5			160	
	61 1570 0609	<b>MCC 6 x 9</b>	7 - 9	100	55,5			160	
	61 1570 0611	<b>MCC 6 x 11</b>	9 - 11	100	55,5			160	
	61 1570 0614	<b>MCC 6 x 14</b>	11 - 14	125	72			198	
	61 1570 0612	<b>MCC 6 x 1/2"</b>	14 - 17	125	72			186	

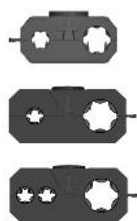

**SAC**

A richiesta possibili combinazioni di due diversi diametri per sella **SAC** - vedere pag. 1 43  
 On request special combinations of two different diameters for each **SAC** Saddle - see page 1 43  
 Nach Anfrage Sonderkombination mit zwei unterschiedlichen Durchmessern pro **SAC** Schelle - siehe Seite 1 43  
 Sur demande des combinaisons spéciales de deux diamètres différents pour garniture **SAC** - voir page 1 43

Fissaggi su piatto, angolare e tondo  
 Fixings on flat, angular and round

Befestigungen an Flach, Winkel und Rund  
 Fixations sur plat, cornière et rond



**SOLUZIONI**  
**PER L'INSTALLAZIONE**

**SOLUTIONS**  
**FOR INSTALLATIONS**



**LÖSUNGEN**  
**FÜR INSTALLATIONEN**

**SOLUTIONS**  
**POUR L'INSTALLATION**

**MCP - Mini fissacavi per profilato PCI 40x22**

Composizione:  
**MCO + inserto scorrevole ISL 8**



**MCP - Mini-Klemmen für C-Profilschienen 40x22**

Zusammenbau:  
**MCO + ISL 8 Schnellmontagemutter**

**MCP - Mini-Clamps for PCI 40x22 section**

Composition:  
**MCO + ISL 8 Sliding insert**



**MCP - Mini fixation pour profilé PCI 40x22**

Composition:  
**MCO + adaptateur rapide ISL 8**

Figura Figure Abbildung Figure	Codice Code Artikel Nr. Code	Articolo Article Artikel Article	ø D	H	h1			g 	Prezzo Price Preis Prix
<p>2 Cavi 2 Kabel</p> <p>2 Cables 2 Câbles</p>	61 1568 0207	<b>MCP 2 x 7</b>	5 - 7	50	18,5			54	
	61 1568 0209	<b>MCP 2 x 9</b>	7 - 9	50	18,5			54	
	61 1568 0211	<b>MCP 2 x 11</b>	9 - 11	50	18,5			54	
	61 1568 0214	<b>MCP 2 x 14</b>	11 - 14	50	24			64	
	61 1568 0212	<b>MCP 2 x 1/2"</b>	14 - 17	50	24			60	
<p>4 Cavi 4 Kabel</p> <p>4 Cables 4 Câbles</p>	61 1568 0407	<b>MCP 4 x 7</b>	5 - 7	75	37			74	
	61 1568 0409	<b>MCP 4 x 9</b>	7 - 9	75	37			74	
	61 1568 0411	<b>MCP 4 x 11</b>	9 - 11	75	37			74	
	61 1568 0414	<b>MCP 4 x 14</b>	11 - 14	100	48			102	
	61 1568 0412	<b>MCP 4 x 1/2"</b>	14 - 17	100	48			94	
<p>6 Cavi 6 Kabel</p> <p>6 Cables 6 Câbles</p>	61 1568 0607	<b>MCP 6 x 7</b>	5 - 7	100	55,5			94	
	61 1568 0609	<b>MCP 6 x 9</b>	7 - 9	100	55,5			94	
	61 1568 0611	<b>MCP 6 x 11</b>	9 - 11	100	55,5			94	
	61 1568 0614	<b>MCP 6 x 14</b>	11 - 14	125	72			132	
	61 1568 0612	<b>MCP 6 x 1/2"</b>	14 - 17	125	72			120	

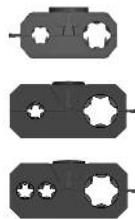

**SAC**

A richiesta possibili combinazioni di due diversi diametri per sella **SAC** - vedere pag. 1 43  
 On request special combinations of two different diameters for each **SAC** Saddle - see page 1 43  
 Nach Anfrage Sonderkombination mit zwei unterschiedlichen Durchmessern pro **SAC** Schelle - siehe Seite 1 43  
 Sur demande des combinaisons spéciales de deux diamètres différents pour garniture **SAC** - voir page 1 43

Fissaggi su profilati a "C"  
Fixings on "C"-profiles

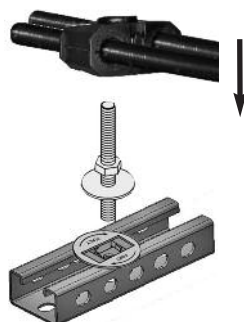
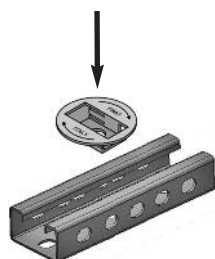

Befestigungen an "C"-Profil  
Fixations sur profilé "C"



**SOLUZIONI**  
**PER L'INSTALLAZIONE**

**SOLUTIONS**  
**FOR INSTALLATIONS**



**LÖSUNGEN**  
**FÜR INSTALLATIONEN**

**SOLUTIONS**  
**POUR L'INSTALLATION**

**MCL - Mini fissacavi da passerelle portacavi in filo**

Composizione:  
**MCO + 2 piastre di spinta PUC 70**



**MCL - Mini Kabelschellen für Gitterbahnen**

Zusammenbau:  
**MCO + 2 PUC 70 Druckplatte**

**MCL - Mini Cable Clamps for steel wire-mesh cable trays**

Composition:  
**MCO + 2 PUC 70 steel pressure plates**



**MCL - Mini Fixations pour chemins de câble en treillis**

Composition:  
**MCO + 2 plaques de compression PUC 70**

Figura Figure Abbildung Figure	Codice Code Artikel Nr. Code	Articolo Article Artikel Article	ø D	H	h1			g 	Prezzo Price Preis Prix
2 Cavi 2 Kabel  2 Cables 2 Câbles	61 1574 0207	<b>MCL 2 x 7</b>	5 - 7	50	18,5	20		62	
	61 1574 0209	<b>MCL 2 x 9</b>	7 - 9	50	18,5	20		62	
	61 1574 0211	<b>MCL 2 x 11</b>	9 - 11	50	18,5	20		62	
	61 1574 0214	<b>MCL 2 x 14</b>	11 - 14	50	24	20		72	
	61 1574 0212	<b>MCL 2 x 1/2"</b>	14 - 17	50	24	20		68	
4 Cavi 4 Kabel  4 Cables 4 Câbles	61 1574 0407	<b>MCL 4 x 7</b>	5 - 7	75	37	20		85	
	61 1574 0409	<b>MCL 4 x 9</b>	7 - 9	75	37	20		85	
	61 1574 0411	<b>MCL 4 x 11</b>	9 - 11	75	37	20		85	
	61 1574 0414	<b>MCL 4 x 14</b>	11 - 14	100	48	20		113	
	61 1574 0412	<b>MCL 4 x 1/2"</b>	14 - 17	100	48	20		150	
6 Cavi 6 Kabel  6 Cables 6 Câbles	61 1574 0607	<b>MCL 6 x 7</b>	5 - 7	100	55,5	20		110	
	61 1574 0609	<b>MCL 6 x 9</b>	7 - 9	100	55,5	20		110	
	61 1574 0611	<b>MCL 6 x 11</b>	9 - 11	100	55,5	20		110	
	61 1574 0614	<b>MCL 6 x 14</b>	11 - 14	125	72	20		143	
	61 1574 0612	<b>MCL 6 x 1/2"</b>	14 - 17	125	72	20		131	

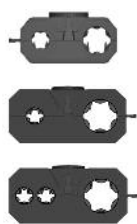

**SAC**

A richiesta possibili combinazioni di due diversi diametri per sella **SAC** - vedere pag. 1 43  
 On request special combinations of two different diameters for each **SAC** Saddle - see page 1 43  
 Nach Anfrage Sonderkombination mit zwei unterschiedlichen Durchmessern pro **SAC** Schelle - siehe Seite 1 43  
 Sur demande des combinaisons spéciales de deux diamètres différents pour garniture **SAC** - voir page 1 43

Fissaggi su passerelle fissacavi in filo d'acciaio  
 Fixings on steel wire cable trays



Befestigungen an Gitterbahnen  
 Fixations sur structures en fil acier

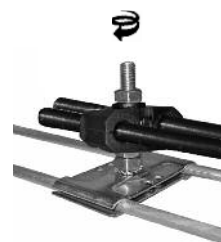
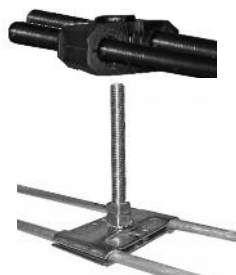

**SOLUZIONI**  
**PER L'INSTALLAZIONE**

**SOLUTIONS**  
**FOR INSTALLATIONS**



**LÖSUNGEN**  
**FÜR INSTALLATIONEN**

**SOLUTIONS**  
**POUR L'INSTALLATION**